



EXCAVATORS

10 TO 49 TONS



OUR MISSION

GRYB wants to fundamentally transform the material handling industry into a customer driven experience, fueled through the needs and challenges of the global market.

Our mission is to develop the right product through the combined expertise of those who build and those who use. Together, we create solutions to support industries that are built to last.

GRYB is the very core of GRYB International. It is through the success of this business that the group went on and expanded into various other brands.

GRYB INTL

GRYB

BATEMAN

WINKLE

SHEAREX

SERCO
LOADERS

e-Trak
Technology Solutions

RADTECH
INNOVATION

DALKO
TECH

TABLE OF CONTENT

4
COUPLING SYSTEMS

16
BUCKETS

24
THUMBS

28
SPECIALTY PRODUCTS

35
TECH SPECS





COUPLING SYSTEMS

AHS WEDGE ATTACHMENT



The AHS Coupling System combines innovation and simplicity. Designed and created by GRYB, this coupling system takes the excavation game to a whole-new level.

The compact design of the AHS includes a hydraulic dual-action, double cylinder and a lock valve, reducing the risk of getting stuck.

The angles of the locking blocks eliminate jamming and facilitate hydraulic unlocking. Available in mechanical or hydraulic configurations, which can be easily converted.



BREAKOUT FORCE



VERSATILITY



INNOVATION

THE AHS IS DESIGNED TO INCREASE PRODUCTIVITY WITH A QUICK RETURN ON YOUR INVESTMENT.

- 1** The capacity of putting your attachments in reverse position optimizes your time on site. Work faster near foundations.
- 2** Efficient installation so that you can focus on getting the job done.
- 3** Reduced risk of breakage or leakage.

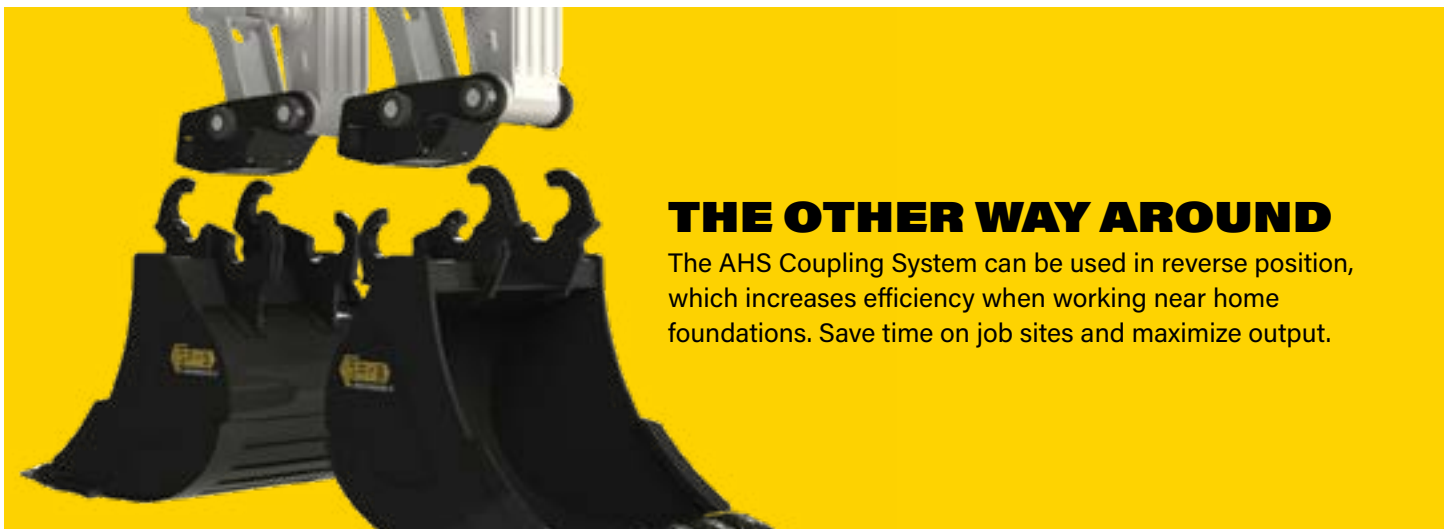

THE OTHER WAY AROUND

The AHS Coupling System can be used in reverse position, which increases efficiency when working near home foundations. Save time on job sites and maximize output.

PIN GRABBER



The GRYB hydraulic Pin Grabber Coupling System allows you to work with a wide range of attachments. Made of heavy-duty steel, the sliding jaw design allows it to fit into multiple pin centers, permitting the handling of various OEM attachments with ease.

Use this equipment in reverse position with all its compatible attachments.



BREAKOUT FORCE



VERSATILITY



INNOVATION

MAXIMIZE UPTIME WITH THE PIN GRABBER.

BE UP AND RUNNING IN NO TIME!

- 1 Take advantage of the versatility this tool can bring to your machine. Perform different tasks without the need for specialized equipment.
- 2 The ability to switch attachments rapidly significantly increases cost savings. Make your business more profitable by using the pin grabber coupling system.
- 3 Safety first. This system enhances safety and eliminates the risk of your operators and their colleagues getting hurt.



DOUBLE SAFETY FEATURE

The Double safety feature offers two advantages. Firstly, it eliminates the likelihood of an attachment dropping on site. Secondly, it prevents incorrect grasping of the pin attached to the lugs. These benefits serve to safeguard you and your colleagues in the event of any hydraulic malfunctions.



1-2 FRONT AND REAR AXLE LOCK

2 HYDRAULIC LOCK VALVE

QUICK HITCH



The Mechanical Quick Hitch Coupling System optimizes the power of your excavator and simplifies your workflow so that you can save on time. Increase your machine's breakout force and switch attachments with ease.

The strong design of this attachment brings incredible value to your workforce. Transfer attachments between your machines of similar carrier weight. The design of the Quick Hitch allows you to use your attachment to its fullest, enabling you to save time and increase profitability!



AVAILABLE FOR 14 TONS EXCAVATOR AND LESS



BREAKOUT FORCE



VERSATILITY



INNOVATION

INCREASED COMPATIBILITY

Having a quick hitch coupler provides the benefit of increased compatibility, allowing for seamless attachment transfer between same-category excavators. It provides a universal connection point, enabling you to use a wide range of tools and implements with your machinery.



TILTING QUICK COUPLER



Convert your standard bucket into a tilt bucket with our Quick Coupler with adjustable tilt, compatible with all our excavator's equipment from 10 to 40 tons. Designs available include a conventional 40° inclination on each side with cylinders configuration and a maximum inclination of 80°.



BREAKOUT FORCE



VERSATILITY



INNOVATION

COMPACT DESIGN

CUSTOM-MADE TO SUIT YOUR NEEDS

MAXIMIZES THE PERFORMANCE OF YOUR ATTACHMENTS



GTR TILTROTATOR COUPLING SYSTEM

Consider the GTR Tiltrotator as an extension to your machine's arm, providing the operator with the power to work with precision, agility, and efficiency.

The GTR Tiltrotator excels on complicated jobs – it will transform your operations by delivering the highest productivity. Unlock endless possibilities with one of the most performant attachments on the market.

PRODUCTIVITY

Move your excavator less and change tools in seconds for maximum uptime.

ACCURACY

To enhance work efficiency, precision and control are necessary. Our secure coupler mechanism employs hydraulic power for all strenuous lifting and joining tasks.

VERSATILITY

Unlock endless possibilities with the GTR Tiltrotator's ability to rotate 360 degrees and tilt 40 degrees left and right.

PROFITABILITY

There are no limits to what you can achieve, so aim high. With minimal effort and maximum output, save hours of operating time. Depending on operator experience, expect a return on investment in the first season of operation.

Ideal for landscaping, complex jobs, hard-to-reach environments that can't be accessed with a regular attachment, as well as jobs with no space to navigate your excavator around.



BREAKOUT FORCE



VERSATILITY



INNOVATION



40 DEGREES OF TILTING

The GTR dual cylinders allow a movement of up to 40 degrees on every side, greatly increasing the versatility of the attachment.



360 DEGREES OF INFINITE ROTATION

The Tiltrotator offers you infinite possibilities. Turn your attachments in any direction to achieve the impossible.

15%

**SAVINGS ON FUEL
WITH SIGNIFICANTLY
DECREASED MACHINE
TRACKING.**

30-40%

**INCREASE IN
PRODUCTIVITY.**

**GREASE-FILLED GEAR
HOUSING IMPROVES
PERFORMANCE
AND DECREASES
MAINTENANCE.**



ADVANCED CONTROL SYSTEM

Control your attachment with unparalleled precision with dual joystick controllers, a graphic touchscreen, optional track and wheel steering as well as multiple user profiles.



OPTIONAL GRIP MODULE

The GRYB grip module takes up very little space under the Tiltrotator and can be easily removed and reattached when needed without affecting the use or connection of the attachment.

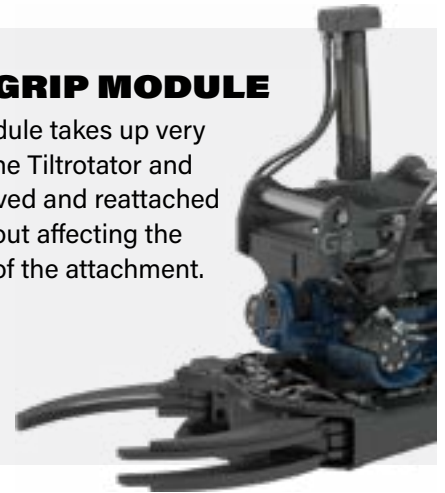

3D GRADE CONTROL GATEWAY

Optional machine control integration systems can bring the Tiltrotator's tilt and rotation sensors into your machines 2D/3D technology.

CENTRALIZED LUBRICATION SYSTEM

Reduces number of lubrication points, can be connected to the excavators lubrication system (if available).

WHEEL/TRACK STEERING

Wheel-Track steering systems are also available for momentary control of these functions from the joysticks.

GTR TILTROTATOR

MOUNT TYPES

The GTR Tiltrotators can be mounted differently according to your needs.



HARDLOCK® QUICK COUPLER

Switch attachments in a flash with the Hardlock® Quick Coupler which offers an added level of safety with double-locking devices, standard rear locking, and excentre locking system.



FAST CHANGE COUPLER

With the Fast Change Coupler, stay in your cab at all times. It will bring maximum time savings to your business. The quick-release system can be combined with an FC Tiltrotator, making it easy to connect and disconnect without having to manually attach hoses.

1 SANDWICH METHOD

With the Hardlock® Quick Coupler or Fast Change Coupler

2 DIRECT FIT

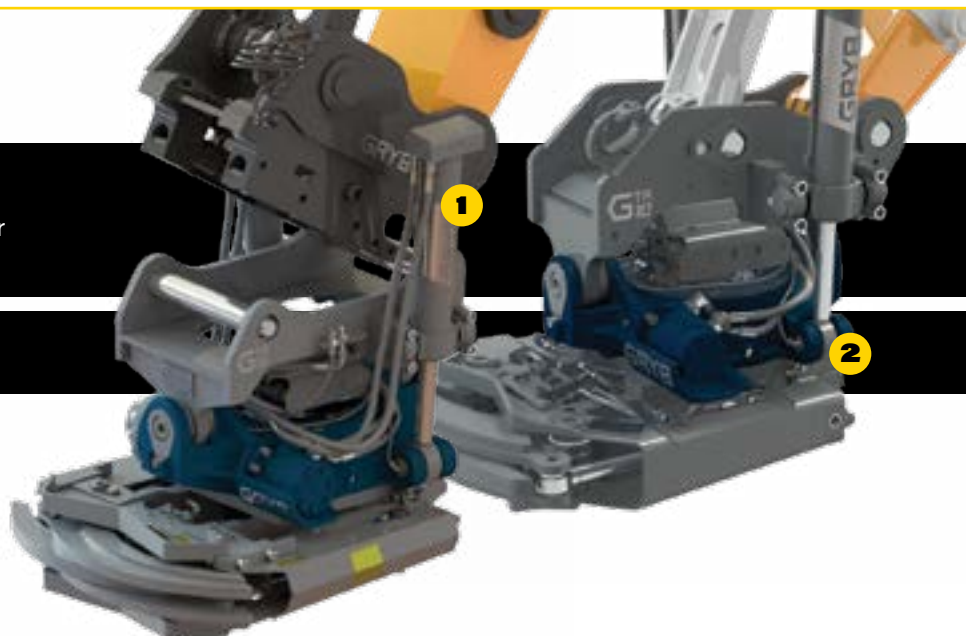

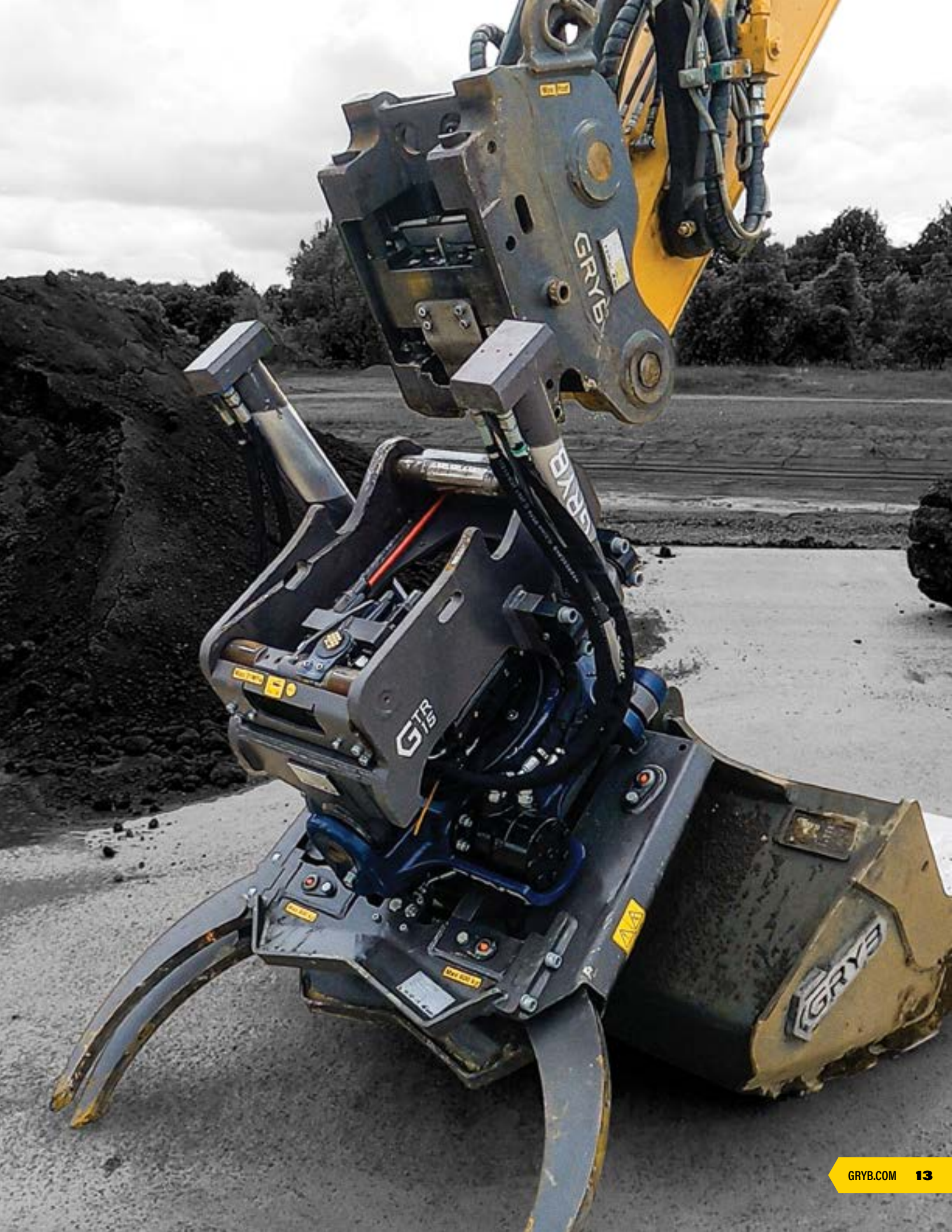





BUCKETS

HD - DIGGING BUCKET

Made to handle various small materials in the construction industry.

Optimized angle filling and dumping.

Reversible attachment available.

Side cutter available bolted or welded.



SHD - SUPER HEAVY DUTY BUCKET

Made to handle various small to medium sized materials in the construction industry, such as stones.

With all the features of the Digging Bucket and more:

- Made of high-resistance steel.
- Optional welded heels available.
- Optional edge protection available.



XHD - EXTREME DUTY BUCKET

Made to dig in extreme conditions and handle all kinds of heavy duty materials.

With all the features of the Super Heavy Duty Bucket and more:

- Thicker wear bars underneath the bucket.
- Made with heavy duty teeth.
- Optional outside and inside reinforcements.
- Optional inner bottom lining.



AVAILABLE BUCKET OPTIONS

Several optional parts are available for additional reinforcement.



COMPARISON CHART

	DIGGING BUCKET HD	SUPER HEAVY DUTY BUCKET SHD	EXTREME DUTY BUCKET XHD
- Under and side plates in High Resistance Steel			
1 Wear Bars			Thicker
2 Tooth size	Standard	Standard	Heavy Duty
3 Side Cutters	Welded/Bolt-on	Welded/Bolt-on	Welded/Bolt-on
4 Welded Heels	N/A	Optional	Optional
5 Edge Protection *	N/A	Optional	Optional
6 Outside Reinforcements	N/A	N/A	Optional
7 Inside Reinforcements	N/A	N/A	Optional
8 Inner Bottom Lining	N/A	N/A	Optional
9 Hook			

* Half Harrow + Chocky bar

DITCHING BUCKET

Filling and dumping at an optimized angle.

Maintenance time reduced.



TILT DITCHING BUCKET

Hydraulic cylinders with total protection from debris.

45° tilt on each side.

Hardened chrome-plate axle with greaseable wearing rings.



SKELETON BUCKET WITH TEETH

Ideal for recycling materials.

Two models available: general-purpose bucket and ditching bucket.

Variable bucket tooth spacing.



4 IN 1 BUCKET

Digs, levels, handles and sort.

Combine use of a grapple, the strength of a standard thumb, and the functions of a ditching bucket.



GRAPPLE BUCKET

Increases precision and control.

Maximizes the performance of your attachments.

Increases the productivity and versatility of your machine.



TRAPEZOIDAL BUCKET

Ideal for digging ditches.

Increase productivity with its 45° angles.



RECESSED BUCKET

Provides the same digging power as the original bucket.

Reduces the risk of the bucket possibly damaging the excavator.



SCREENING BUCKET

Ideal for recycling materials.

Sieve opening from 1 to 6 inches are available.

Rotates on both sides.



GRADING BUCKET

WITH MINIMIZED CORNERS

Minimized corners for a better clearance during the Tiltrotator's rotation.

Optimized material selection to lower weight without compromising durability.

Available with a bolt-on cutting edge.



COUPLING SYSTEMS COMPATIBILITY

GTR

DIGGING BUCKET

Optimized material selection to lower weight without compromising durability.

Pre-drilled holes ready for bolt-on side cutters.

Back wear plates made of abrasion-resistant AR500 steel.

Available in multiple teeth configurations.



COUPLING SYSTEMS COMPATIBILITY

GTR

TRENCH BUCKET

Dig deep trenches without the Tiltrotator having to go below the surface level.

Optimized material selection to lower weight without compromising durability.

Back wear plates made of abrasion-resistant AR500 steel.



COUPLING SYSTEMS COMPATIBILITY

GTR





THUMBS

HYDRAULIC THUMB ON STICK AXLE

Choice of two or four profiled tines.

135° rotation.

XHD cylinders included from 10 to 40 tons.



COUPLING SYSTEMS COMPATIBILITY

ALL

PROGRESSIVE HYDRAULIC THUMB

Choice of two or four profiled tines.

More than 180° rotation.

XHD cylinders included from 10 to 40 tons.



COUPLING SYSTEMS COMPATIBILITY

ALL

UNIVERSAL HYDRAULIC THUMB

130° rotation.

Cushion-shock absorbers are included.

Light and compact design.

Two possible length setups.



COUPLING SYSTEMS COMPATIBILITY

ALL







SPECIALTY PRODUCTS

FEMALE LUGS

Compatible with all types of wedge or pin-on attachments.

With or without excess under the quick coupler.

Available in standard or reversible configurations to fit your needs.



FEMALE LUGS WITH TOP PLATE

Compatible with all types of wedge or pin-on attachments.

Custom-made to fit your needs.



REVERSIBLE FEMALE LUGS

Compatible with all wedge couplers.

With or without excess under the wedge coupler.



ROOT RAKE

Multiple configuration available for the spacing between tines.



CONCRETE PULVERIZER

Stronger jaw on the market.

Mounted on a bolt-on interchangeable top plate.

Fastest execution system and the biggest strength ratio on the market.



RIPPER

Offers superior digging force.

Interchangeable bolt-on teeth.

Minimal maintenance is required.



FC ADAPTER PLATE

Flexible and robust.

Mount different tools and attachments.

Designed for the Nordic market.



COUPLING SYSTEMS COMPATIBILITY

GTR

PALLET FORK

Multiple mechanical configuration available.

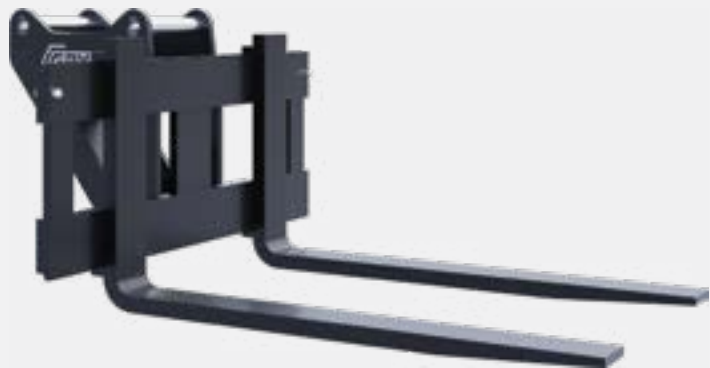

COUPLING SYSTEMS COMPATIBILITY

GTR

ASPHALT CUTTER

Designed to last.



COUPLING SYSTEMS COMPATIBILITY

GTR

CONSTRUCTION GRAPPLE

Perfect tool to widen the range of operation available with the tiltrotator.

Application areas include heavy lifting, stone laying, sorting, loading of cut-to-length timber, waste wood handling, light demolition etc.

High clamping force.



COUPLING SYSTEMS COMPATIBILITY

GTR

SORTING GRAPPLE

Suited for use in building and construction sites and recycling.

Load retention valve and piston accumulator integrated with the hydraulic system.

Very stable.

Close tip to tip.



COUPLING SYSTEMS COMPATIBILITY

GTR



EXCAVATORS

COMPATIBLE ATTACHMENTS SPECIFICATIONS

36
COUPLERS

38
BUCKETS

46
THUMBS

47
SPECIALTY

COUPLING SYSTEMS



AHS WEDGE ATTACHMENT

MODEL	CLASS	MACHINE WEIGHT TONS	WEIGHT LBS	LOCKING SYSTEM
AHB120	120	10 to 15	285	Mechanic or Hydraulic
AHS160	160	16 to 19	415	Mechanic or Hydraulic
AHS200	200	20 to 23	500	Mechanic or Hydraulic
AHS270	270	24 to 29	760	Mechanic or Hydraulic
AHS300	300	30 to 39	860	Mechanic or Hydraulic
AHS400	400	40 to 49	1,135	Mechanic or Hydraulic



PIN GRABBER

MODEL	CLASS	MACHINE WEIGHT TONS	WEIGHT LBS	FRONT PIN DIAMETER MM	LOCKING TYPE	LOCKING SYSTEM
PGH060	120	10 to 15	490	60	Sliding jaw	Hydraulic
PGH065	120	10 to 15	485	65	Sliding jaw	Hydraulic
PGH070	160	16 to 19	675	70	Sliding jaw	Hydraulic
PGH080	160 to 270	16 to 29	810	80	Sliding jaw	Hydraulic
PGH090	270 to 300	24 to 39	1,240	90	Sliding jaw	Hydraulic
PGH100	300 to 400	30 to 49	1,435	100	Sliding jaw	Hydraulic
PGH110	400	40 to 49	1,620	110	Sliding jaw	Hydraulic



TILT COUPLER

For more information on this product, please contact our sales team.



QUICK HITCH

MODEL	CLASS	MACHINE WEIGHT TONS	WEIGHT LBS	LOCKING SYSTEM
PWR250	120	10 to 15	425	Mechanic

COUPLING SYSTEMS



HARDLOCK® QUICK COUPLER

MODEL	MACHINE WEIGHT TONS	WEIGHT LBS	LOCKING
S40	2-6	77	Hydraulic
S45	5-12	198	Hydraulic
S60	12-18	170	Hydraulic
S70	17-25	320	Hydraulic



FAST CHANGE COUPLER

MODEL	ARMAMENT	ELECTRICAL CONNECTION	MACHINE WEIGHT TONS	LOCKING
HL-S60-FC	5X (2 X 3/8", 1 X 1/2", 2 X 3/4")	V14	10 to 19	Hydraulic
HL-S70-FC	5X (2 X 1/2", 3 X 3/4")	V14	20 to 29	Hydraulic
FC45	3x3/8" and 2x1/2"	V14	5 to 10	Hydraulic

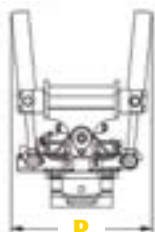
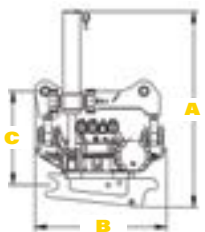

GTR-15

GTR-18

GTR-22

GTR-28

Machine Weight	TONS	10 to 15	14 to 18	16 to 22	22 to 30
Approx Weight	LBS	816	1,080	1,367	1,653
Fit		Direct Fit/ S60 Hardlock or FC60-5	Direct Fit/ S60 Hardlock or FC 60-5	Direct Fit/ S70 Hardlock or FC70	Direct Fit/ S70 Hardlock or FC70
Dimensions* A / B / C / D	IN	36 / 29 / 18 / 26	36 / 30 / 20 / 32	39 / 33 / 24 / 33	43 / 40 / 26 / 34
Recommended Max Oil Flow	GPM	26	32	32	32
Working Pressure Max	PSI	3,046	3,046	3,046	3,046
Tilt Torque @ 3'000PSI / 21 Mpa	LBS/FT	25,151	33,928	38,353	39,091
Rotation Speed	SEC/ROTATION	7	7	7	7
Turn Torque	LBS/FT	5,162	4,425	5,162	5,162
Max Breakout Torque	LBS/FT	105,471	136,449	169,639	228,644
Max Breakout Force	LBS	24,729	29,225	33,722	40,466
Max Bucket Width	INCH	60	72	80	80

*Dimensions may vary depending on configuration and options.

BUCKETS



DIGGING BUCKET

MODEL	MACHINE WEIGHT TONS	WEIGHT LBS	WIDTH IN	CAPACITY YD ³	NUMBER OF TEETH
GOD120-18L035D3	10 to 15	935	20	0.35	3
GOD120-24L045D4	10 to 15	1,065	26	0.45	4
GOD120-30L070D4	10 to 15	1,160	32	0.70	4
GOD120-30L070D5	10 to 15	1,190	32	0.70	5
GOD120-36L085D5	10 to 15	1,285	38	0.85	5
GOD120-36L085D6	10 to 15	1,315	38	0.85	6
GOD120-42L100D5	10 to 15	1,390	44	1.00	5
GOD120-42L100D7	10 to 15	1,450	44	1.00	7
GOD120-48L120D6	10 to 15	1,510	50	1.20	6
GOD160-24L050D3	16 to 19	1,290	26	0.55	3
GOD160-24L050D3	16 to 19	1,300	26	0.50	4
GOD160-30L075D4	16 to 19	1,450	32	0.50	4
GOD160-30L075D5	16 to 19	1,470	32	0.75	5
GOD160-36L095D5	16 to 19	1,595	38	0.95	5
GOD160-36L095D6	16 to 19	1,620	38	0.95	6
GOD160-42L110D5	16 to 19	1,690	44	1.10	5
GOD160-42L110D7	16 to 19	1,750	44	1.10	7
GOD160-48L130D6	16 to 19	1,835	50	1.30	6
GOD160-48L130D8	16 to 19	1,890	50	1.30	8
GOD200-24L065D3	20 to 23	1,500	26.5	0.65	3
GOD200-24L065D4	20 to 23	1,540	26.5	0.65	4
GOD200-30L085D4	20 to 23	1,680	32.5	0.85	4
GOD200-30L085D5	20 to 23	1,860	38.5	1.05	5
GOD200-42L130D5	20 to 23	2,010	44.5	1.30	5
GOD200-42L130D6	20 to 23	2,050	44.5	1.30	6
GOD200-48L155D5	20 to 23	2,150	50.5	1.55	5
GOD200-48L155D7	20 to 23	2,225	50.5	1.55	7
GOD270-24L075D3	24 to 29	2,010	27	0.75	3
GOD270-30L100D3	24 to 29	2,180	33	1.00	3
GOD270-30L100D4	24 to 29	2,230	33	1.00	4
GOD270-36L125D4	24 to 29	2,400	39	1.25	4
GOD270-36L125D5	24 to 29	2,450	39	1.25	5
GOD270-42L150D5	24 to 29	2,615	44	1.50	5

BUCKETS



DIGGING BUCKET

MODEL	MACHINE WEIGHT TONS	WEIGHT LBS	WIDTH IN	CAPACITY YD ³	NUMBER OF TEETH
GOD270-48L175D5	24 to 29	2,785	50	1.75	5
GOD270-48L175D6	24 to 29	2,835	50	1.75	6
GOD270-54L200D6	24 to 29	3,000	56	2.00	6
GOD270-54L200D7	24 to 29	3,055	56	2.00	7
GOD270-60L225D6	24 to 29	3,170	62	2.25	6
GOD270-60L225D8	24 to 29	3,275	62	2.25	8
GOD300-24L080D3	30 to 39	2,800	27	0.80	3
GOD300-30L105D3	30 to 39	3,000	33	1.05	3
GOD300-36L135D4	30 to 39	3,270	39	1.35	4
GOD300-42L165D4	30 to 39	3,460	45	1.65	4
GOD300-42L175D5	30 to 39	3,540	45	1.65	5
GOD300-48L200D5	30 to 39	3,725	51	2.00	5
GOD300-54L220D5	30 to 39	3,910	57	2.20	5
GOD300-54L220D6	30 to 39	3,990	57	2.20	6
GOD300-60L250D6	30 to 39	4,180	63	2.50	6
GOD300-60L265D7	30 to 39	4,260	63	2.50	7
GOD400-30L135D3	40 to 49	4,260	33	1.35	3
GOD400-36L175D4	40 to 49	4,690	39	1.70	4
GOD400-42L205D4	40 to 49	5,000	45	2.05	4
GOD400-48L245D4	40 to 49	5,310	51	2.45	4
GOD400-48L245D5	40 to 49	5,425	51	2.45	5
GOD400-54L275D5	40 to 49	5,740	57	2.80	5
GOD400-60L300D5	40 to 49	6,050	63	2.75	5
GOD400-60L300D6	40 to 49	6,165	63	3.15	6
GOD400-66L355D5	40 to 49	6,360	69	3.55	5
GOD400-66L355D6	40 to 49	6,480	69	3.55	6
GOD400-72L390D6	40 to 49	6,790	75	3.90	6

BUCKETS



SUPER HEAVY DUTY BUCKET

MODEL	MACHINE WEIGHT TONS	WEIGHT LBS	WIDTH IN	CAPACITY YD ³	NUMBER OF TEETH
GOD120-18L035D3-S	10 to 15	935	20	0.35	3
GOD120-24L045D4-S	10 to 15	1,065	26	0.45	4
GOD120-30L070D4-S	10 to 15	1,160	32	0.70	4
GOD120-30L070D5-S	10 to 15	1,190	32	0.70	5
GOD120-36L085D5-S	10 to 15	1,285	38	0.85	5
GOD120-36L085D6-S	10 to 15	1,315	38	0.85	6
GOD120-42L100D5-S	10 to 15	1,390	44	1.00	5
GOD120-42L100D7-S	10 to 15	1,450	44	1.00	7
GOD120-48L120D6-S	10 to 15	1,510	50	1.20	6
GOD160-24L050D3-S	16 to 19	1,290	26	0.55	3
GOD160-24L050D3-S	16 to 19	1,300	26	0.50	4
GOD160-30L075D4-S	16 to 19	1,450	32	0.50	4
GOD160-30L075D5-S	16 to 19	1,470	32	0.75	5
GOD160-36L095D5-S	16 to 19	1,595	38	0.95	5
GOD160-36L095D6-S	16 to 19	1,620	38	0.95	6
GOD160-42L110D5-S	16 to 19	1,690	44	1.10	5
GOD160-42L110D7-S	16 to 19	1,750	44	1.10	7
GOD160-48L130D6-S	16 to 19	1,835	50	1.30	6
GOD160-48L130D8-S	16 to 19	1,890	50	1.30	8
GOD200-24L065D3-S	20 to 23	1,500	26.5	0.65	3
GOD200-24L065D4-S	20 to 23	1,540	26.5	0.65	4
GOD200-30L085D4-S	20 to 23	1,680	32	0.85	4
GOD200-30L085D5-S	20 to 23	1,860	38.5	1.05	5
GOD200-42L130D5-S	20 to 23	2,010	44.5	1.30	5
GOD200-42L130D6-S	20 to 23	2,050	44.5	1.30	6
GOD200-48L155D5-S	20 to 23	2,150	50.5	1.55	5
GOD200-48L155D7-S	20 to 23	2,225	50.5	1.55	7
GOD270-24L075D3-S	24 to 29	2,010	27	0.75	3
GOD270-30L100D3-S	24 to 29	2,180	33	1.00	3
GOD270-30L100D4-S	24 to 29	2,230	33	1.00	4
GOD270-36L125D4-S	24 to 29	2,400	39	1.25	4

BUCKETS



SUPER HEAVY DUTY BUCKET

MODEL	MACHINE WEIGHT TONS	WEIGHT LBS	WIDTH IN	CAPACITY YD ³	NUMBER OF TEETH
GOD270-36L125D5-S	24 to 29	2,450	39	1.25	5
GOD270-42L150D5-S	24 to 29	2,615	44	1.50	5
GOD270-48L175D5-S	24 to 29	2,785	50	1.75	5
GOD270-48L175D6-S	24 to 29	2,835	50	1.75	6
GOD270-54L200D6-S	24 to 29	3,000	56	2.00	6
GOD270-54L200D7-S	24 to 29	3,055	56	2.00	7
GOD270-60L225D6-S	24 to 29	3,170	62	2.25	6
GOD270-60L225D8-S	24 to 29	3,275	62	2.25	8
GOD300-24L080D3-S	30 to 39	2,800	27	0.80	3
GOD300-30L105D3-S	30 to 39	3,000	33	1.05	3
GOD300-36L135D4-S	30 to 39	3,270	39	1.35	4
GOD300-42L165D4-S	30 to 39	3,460	45	1.65	4
GOD300-42L175D5-S	30 to 39	3,540	45	1.65	5
GOD300-48L200D5-S	30 to 39	3,725	51	2.00	5
GOD300-54L220D5-S	30 to 39	3,910	57	2.20	5
GOD300-54L220D6-S	30 to 39	3,990	57	2.20	6
GOD300-60L265D6-S	30 to 39	4,180	63	2.50	6
GOD300-60L265D7-S	30 to 39	4,260	63	2.50	7
GOD400-30L135D3-S	40 to 49	4,260	33	1.35	3
GOD400-36L175D4-S	40 to 49	4,690	39	1.70	4
GOD400-42L205D4-S	40 to 49	5,000	45	2.05	4
GOD400-48L245D4-S	40 to 49	5,310	51	2.45	4
GOD400-48L245D5-S	40 to 49	5,425	51	2.45	5
GOD400-54L275D5-S	40 to 49	5,740	57	2.80	5
GOD400-60L300D5-S	40 to 49	6,050	63	2.75	5
GOD400-60L300D6-S	40 to 49	6,165	63	3.15	6
GOD400-66L355D5-S	40 to 49	6,360	69	3.55	5
GOD400-66L355D6-S	40 to 49	6,480	69	3.55	6
GOD400-72L390D6-S	40 to 49	6,790	75	3.90	6
GOD400-72L390D7-S	40 to 49	6,905	75	3.90	7

BUCKETS



EXTREME DUTY BUCKET

For more information on this product, please contact our sales team.



TRAPEZOIDAL BUCKET

MODEL	MACHINE WEIGHT TONS	WEIGHT LBS	WIDTH IN	CAPACITY YD ³
GPV120-66F	10 to 15	875	66	0.9
GPV160-66F	16 to 19	925	66	0.9
GPV200-86G	20 to 23	1,500	86	1.4
GPV270-92H	24 to 29	2,750	92	2.0
GPV300-94I	30 to 39	2,950	94	2.3



SKELETON BUCKET WITH TEETH

For more information on this product, please contact our sales team.



4 IN 1 BUCKET

For more information on this product, please contact our sales team.



GRAPPLE BUCKET

For more information on this product, please contact our sales team.

BUCKETS



DITCHING BUCKET

MODEL	MACHINE WEIGHT TONS	WEIGHT LBS	WIDTH IN	CAPACITY YD ³
GAF120-48E	10 to 15	1,030	48	0.80
GAF120-60F	10 to 15	1,200	60	1.00
GAF120-66G	10 to 15	1,280	66	1.10
GAF120-72G	10 to 15	1,360	72	1.30
GAF160-60G	16 to 19	1,260	60	1.30
GAF160-66G	16 to 19	1,350	66	1.40
GAF160-72H	16 to 19	1,440	72	1.60
GAF200-60G	20 to 23	1,690	60	1.50
GAF200-66H	20 to 23	1,895	66	1.80
GAF200-72H	20 to 23	2,000	72	2.00
GAF200-78I	20 to 23	2,125	78	2.10
GAF270-72H	24 to 29	2,050	72	2.00
GAF270-78I	24 to 29	2,165	78	2.20
GAF270-84I	24 to 29	2,280	84	2.40
GAF300-72J	30 to 39	3,040	72	2.60
GAF300-78J	30 to 39	3,250	78	2.80
GAF300-84J	30 to 39	3,428	84	3.00
GAF400-72K	40 to 49	3,970	72	3.30
GAF400-78L	40 to 49	4,175	78	3.70
GAF400-84L	40 to 49	4,380	84	4.00

BUCKETS



SCREENING BUCKET

MODEL	MACHINE WEIGHT TONS	CATEGORY	WEIGHT LBS	WIDTH IN	CAPACITY YD ³
GT120	10 to 19	120	2,650	52	1.00
GT200	20 to 29	200	4,150	60	1.50
GT300	30 to 39	300	5,200	68	2
GT400	30 to 39	400	7,000	74	2.75



BUCKETS



TILT DITCHING BUCKET

MODEL	MACHINE WEIGHT TONS	WEIGHT LBS	WIDTH IN	CAPACITY YD ³
GPT120-60E	10 to 15	1,420	60	0.7
GPT120-66F	10 to 15	1,510	66	0.8
GPT120-72F	10 to 15	1,660	72	0.9
GPT160-60F	16 to 19	1,475	60	0.8
GPT160-66F	16 to 19	1,570	66	0.9
GPT160-72F	16 to 19	1,760	72	1.0
GPT200-60G	20 to 23	2,500	60	1.2
GPT200-66G	20 to 23	2,650	66	1.3
GPT200-72G	20 to 23	2,800	72	1.4
GPT270-72H	24 to 29	2,425	72	1.5
GPT270-78H	24 to 29	2,700	78	1.0
GPT300-72I	30 to 39	3,380	72	2.1
GPT300-78I	30 to 39	3,580	78	2.3
GPT300-84I	30 to 39	3,700	84	2.5



RECESSED BUCKET

MODEL	MACHINE WEIGHT TONS	WEIGHT LBS	WIDTH IN	CAPACITY YD ³	NUMBER OF TEETH
GRD120-30E4	10 to 15	1,160	30	0.7	4
GRD120-36F5	10 to 15	1,190	36	0.9	5
GRD120-42F5	10 to 15	1,390	42	1	5
GRD160-30E5	16 to 19	1,450	30	0.8	4
GRD160-36F5	16 to 19	1,500	36	1.0	5
GRD160-42G5	16 to 19	1,690	42	1.1	5
GRD200-36G5	20 to 23	1,860	36	1.1	5
GRD200-42G5	20 to 23	2,140	42	1.3	5
GRD200-48G5	20 to 23	2,150	48	1.5	5
GRD270-42G5	24 to 29	2,500	42	1.5	5
GRD270-48H5	24 to 29	2,785	48	1.7	5
GRD270-54H6	24 to 29	3,000	54	2.0	6
GRD300-42H4	30 to 39	3,460	42	1.6	4
GRD300-48H5	30 to 39	3,500	48	2.0	5
GRD300-54I5	30 to 39	3,910	54	2.2	5

BUCKETS



GRADING BUCKET

MODEL	MACHINE WEIGHT TONS	WEIGHT LBS	WIDTH IN	CAPACITY YD ³
GEF120-60E-S60	10 to 15	1,140	60	0.8
GEF120-66F-S60	10 to 15	1,245	66	0.9
GEF120-96G-S60	10 to 15	1,635	96	1.3
GEF160-60F-S60	16 to 19	1,340	60	1.0
GEF160-66G-S60	16 to 19	1,465	66	1.2
GEF200-48F-S70	20 to 23	1,370	48	0.9
GEF200-66G-S70	20 to 23	1,820	66	1.4
GEF200-72G-S70	20 to 23	1,995	72	1.5
GEF200-96I-S70	20 to 23	2,450	96	2.1
GEF270-72H-S70	24 to 29	2,445	72	1.8
GEF270-78H-S70	24 to 29	2,640	78	2.0



TRENCH BUCKET

MODEL	MACHINE WEIGHT TONS	WEIGHT LBS	WIDTH IN	CAPACITY YD ³	NUMBER OF TEETH
GET120-16D0-S60	10 to 15	680	16	0.4	0
GET120-16D3-S60	10 to 15	760	16	0.4	3
GET120-20D0-S60	10 to 15	720	20	0.4	0
GET120-20D3-S60	10 to 15	805	20	0.4	3
GET160-18D0-S60	16 to 19	880	18	0.5	0
GET160-18D3-S60	16 to 19	950	18	0.5	3
GET200-24E0-S70	20 to 23	1,295	24	0.7	0
GET200-24E3-S70	20 to 23	1,400	24	0.7	3
GET270-26F0-S70	24 to 29	1,625	26	0.9	0
GET270-26F3-S70	24 to 29	1,750	26	0.9	3

BUCKETS



DIGGING BUCKET

MODEL	MACHINE WEIGHT TONS	TYPE OF RESISTANCE	WEIGHT LBS	WIDTH IN	CAPACITY YD ³	NUMBER OF TEETH
GED120-30E5-S60	10 to 15	HD	1,125	32	0.7	5
GED120-30Z5-S60	10 to 15	SHD	1,125	32	0.7	5
GED120-36F5-S60	10 to 15	HD	1,225	38	0.9	5
GED120-36F6-S60	10 to 15	HD	1,255	38	0.9	6
GED120-36Z5-S60	10 to 15	SHD	1,225	38	0.9	5
GED120-36Z6-S60	10 to 15	SHD	1,255	38	0.9	6
GED120-40F5-S60	10 to 15	HD	1,290	42	1.0	5
GED120-40F6-S60	10 to 15	HD	1,320	42	1.0	6
GED120-40Z5-S60	10 to 15	SHD	1,290	42	1.0	5
GED120-40Z6-S60	10 to 15	SHD	1,320	42	1.0	6
GED160-36F5-S60	16 to 19	HD	1,470	38	1.0	5
GED160-36F6-S60	16 to 19	HD	1,500	38	1.0	6
GED160-36Z5-S60	16 to 19	SHD	1,470	38	1.0	5
GED160-36Z6-S60	16 to 19	SHD	1,500	38	1.0	6
GED160-40G5-S60	16 to 19	HD	1,555	42	1.1	5
GED160-40G6-S60	16 to 19	HD	1,585	42	1.1	6
GED160-40Z5-S60	16 to 19	SHD	1,555	42	1.1	5
GED160-40Z6-S60	16 to 19	SHD	1,585	42	1.1	6
GED160-42G5-S60	16 to 19	HD	1,600	44	1.15	5
GED160-42G6-S60	16 to 19	HD	1,625	44	1.15	6
GED160-42G7-S60	16 to 19	HD	1,650	44	1.2	7
GED160-42Z5-S60	16 to 19	SHD	1,600	44	1.2	5
GED160-42Z6-S60	16 to 19	SHD	1,625	44	1.2	6
GED160-42Z7-S60	16 to 19	SHD	1,650	44	1.2	7
GED200-42G5-S70	20 to 23	HD	2,055	45	1.3	5
GED200-42G6-S70	20 to 23	HD	2,090	45	1.3	6
GED200-42Z5-S70	20 to 23	SHD	2,055	45	1.3	5
GED200-42Z6-S70	20 to 23	SHD	2,090	45	1.3	6
GED200-48H5-S70	20 to 23	HD	2,210	51	1.6	5
GED200-48H6-S70	20 to 23	HD	2,245	51	1.6	6
GED200-48Z5-S70	20 to 23	SHD	2,210	51	1.6	5
GED200-48Z6-S70	20 to 23	SHD	2,245	51	1.6	6
GED270-42G5-S70	24 to 29	HD	2,495	45	1.5	5
GED270-42Z5-S70	24 to 29	SHD	2,495	45	1.5	5
GED270-48H5-S70	24 to 29	HD	2,675	51	1.8	5
GED270-48H6-S70	24 to 29	HD	2,725	51	1.8	6
GED270-48Z5-S70	24 to 29	SHD	2,675	51	1.8	5
GED270-48Z6-S70	24 to 29	SHD	2,725	51	1.8	6
GED270-54H6-S70	24 to 29	HD	2,900	57	2.0	6
GED270-54H7-S70	24 to 29	HD	2,955	57	2.0	7
GED270-54Z6-S70	24 to 29	SHD	2,900	57	2.0	6
GED270-54Z7-S70	24 to 29	SHD	2,955	57	2.0	7

THUMBS



HYDRAULIC THUMB ON STICK AXLE

MODEL	CATEGORY	WEIGHT LBS	NUMBER OF TINES
POB120-2L	120	550	2
POB120-4L	120	660	4
POB160-2L	160	630	2
POB160-4L	160	790	4
POB200-2L	200	950	2
POB200-4L	200	1,140	4
POB270-2L	270	1,150	2
POB270-4L	270	1,380	4
POB300-2L	300	1,400	2
POB300-4L	300	1,775	4
POB400-4L	400	3,125	4



PROGRESSIVE HYDRAULIC THUMB

For more information on this product, please contact our sales team.



UNIVERSAL HYDRAULIC THUMB

MODEL	CATEGORY	WEIGHT LBS	NUMBER OF TINES	LENGHT INCH
POG1216	120/160	465	2	52 or 61
POG2027	200/270	755	2	61 or 73
POG3045-68L	300/400	1,940	2	68
POG3045-74L	300/400	1,980	2	74
POG3045-85L	300/400	2,105	2	85

SPECIALTY PRODUCTS



FEMALE LUGS

For more information on this product, please contact our sales team.



FEMALE LUGS WITH TOP PLATE

For more information on this product, please contact our sales team.



REVERSIBLE FEMALE LUGS

For more information on this product, please contact our sales team.



SPECIALTY PRODUCTS



ROOT RAKE

MODEL	CLASS	WEIGHT LBS	WIDTH IN	DISTANCE BETWEEN TINES IN	NUMBER OF TINES
PEI120-60L6	120	1,190	60	10-7/8	6
PEI120-60L7	120	1,260	60	8-7/8	7
PEI160-60L6	160	1,590	60	10-5/8	6
PEI160-72L7	160	1,815	72	10-5/8	7
PEI200-72L6	200	1,870	72	13	6
PEI200-72L7	200	2,030	72	10-5/8	7
PEI270-72L7	270	2,500	72	10-5/8	7
PEI300-84L7	300	3,250	78	12-3/8	7
PEI300-96L8	300	3,620	96	12-1/8	8
PEI400-84L8	400	4,580	84	9-5/8	8
PEI400-96L9	400	5,580	96	9-3/4	9



CONCRETE PULVERIZER

For more information on this product, please contact our sales team.



RIPPER

MODEL	CATEGORY	LENGTH IN	WEIGHT LBS
RIP1216	120/160	36	380
RIP200	200	42	580
RIP270	270	44	770
RIP300	300	48	960
RIP400	400	54	1,320

SPECIALTY PRODUCTS



FC ADAPTER PLATE

MODEL	ATTACHMENT	MACHINE WEIGHT TONS
Simple plate	S45*	6-10
Simple plate	S60	10-16
Simple plate	S70	16-30
Simple plate	S80	31-40

*Available in 2024



PALLET FORK

MODEL	MACHINE WEIGHT TONS	WEIGHT LBS	WIDTH IN	CAPACITY PER PAIR @ 24" IN	FORK DIMENSIONS IN	GTR COMPAT.
FLI04-60LBD48-S60	10 to 19	1,370	60	12,600	6 X 2.0 X 48	GTR15 - GTR18
FLI04-60LDE60-S60	10 to 19	1,425	60	12,600	6 X 2.0 X 60	GTR15 - GTR18
FLI04-60LFE48-S70	20 to 29	1,555	60	21,100	6 X 2.5 X 48	GTR22 - GTR28
FLI04-60LFE60-S70	20 to 29	1,610	60	21,100	6 X 2.5 X 60	GTR22 - GTR28



ASPHALT CUTTER

MODEL	MACHINE WEIGHT TONS	AXLE DIAM. MM	PULLEY DIAM. IN	WEIGHT LBS	GTR COMPAT.
COA075-19D-S60	10 to 19	60	19	410	GTR015 - GTR18

SPECIALTY PRODUCTS



CONSTRUCTION GRAPPLE

MODEL		15	25	40	55	80
Max. Working Pressure	PSI	3,626	3,626	3,626	3,626	3,626
Tip Force, Tip to Tip	LBS	2,248	4,047	3,822	3,822	10,341
Opening Time at 18 GPM	S	0.4	0.8	1.1	1.7	3.6
Closing Time at 18 GPM	S	0.6	1.4	1.7	2.5	5.2
Length, Closed Grapple	IN	29.1	31.5	38.0	43.3	53.3
Max. Grapple Opening	IN	46.1	57.5	81.7	94.1	111.8
Max. Width	IN	15.6	20.1	21.7	21.7	31.5
Width, Outer Claw	IN	14.0	17.1	18.6	18.6	28.1
Height, Closed Grapple	IN	20.1	22.0	25.0	27.0	34.8
Height, Open Grapple	IN	27.0	28.5	25.8	28.5	37.0
Min. Load Diameter	IN	3.5	3.9	5.9	7.1	6.9
Load Area	FT ²	1.6	2.7	4.3	5.9	8.6
Max load	LBS	6,614	11,023	15,432	15,432	22,046
Weight	LBS	364	639	750	838	1,830



SORTING GRAPPLE

MODEL		15	25	40	55	80
Max. Working Pressure	PSI	3,626	3,626	3,626	3,626	3,626
Tip Force, Tip to Tip	LBS	2,023	4,046	3,821	3,821	10,341
Opening Time at 18 GPM	S	0.4	0.5	0.8	0.9	2.2
Closing Time at 18 GPM	S	0.7	0.8	1.4	1.6	3.5
Length, Closed Grapple	IN	28	30.3	35	39.8	48
Max. Grapple Opening	IN	55	59	79	92	104
Max. Width	IN	17.3	20	21.7	21.7	31.5
Width, Outer Claw	IN	16.7	20.5	20.5	35.4	47.2
Height, Closed Grapple	IN	27.8	31	34.7	38	50.8
Height, Open Grapple	IN	20.8	20.6	16.5	18.9	37
Min. Load Diameter	IN	14	20	23	25.5	26
Load Area	FT ²	1.3	1.8	2.3	2.9	5
Max load	LBS	3,000	5,000	7,000	7,000	10,000
Weight	LBS	441	705	838	1,301	2,425





1-844-604-1396 - INFO@GRYB.COM

FOLLOW US     



GRYB.COM